

.steute

Meditec

INTUITIVE CONTROLS FOR MEDICAL EQUIPMENT

Cable-free hand and foot controls with safe wireless technology

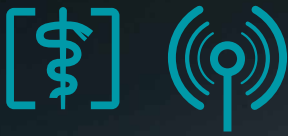

A SHORT INTRODUCTION: STEUTE MEDITEC



FOR MORE THAN 30 YEARS STEUTE HAS BEEN DEVELOPING AND MANUFACTURING CONTROL DEVICES FOR MEDICAL EQUIPMENT

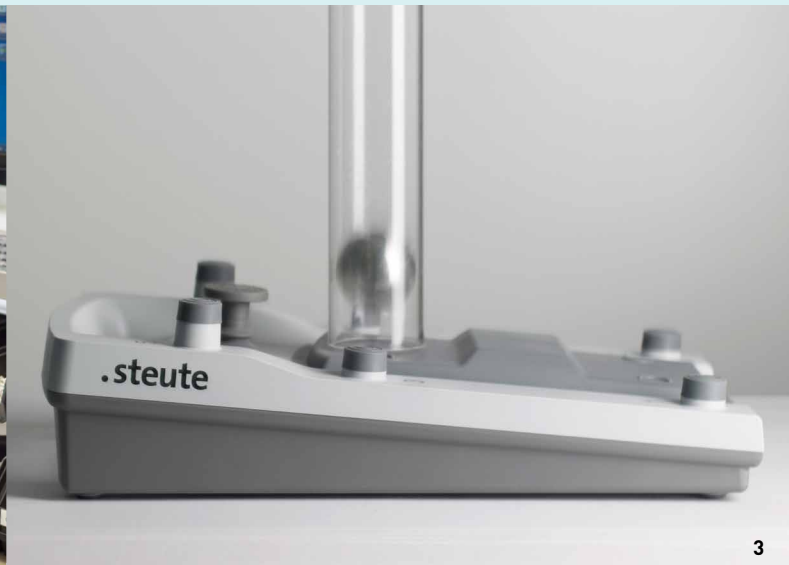
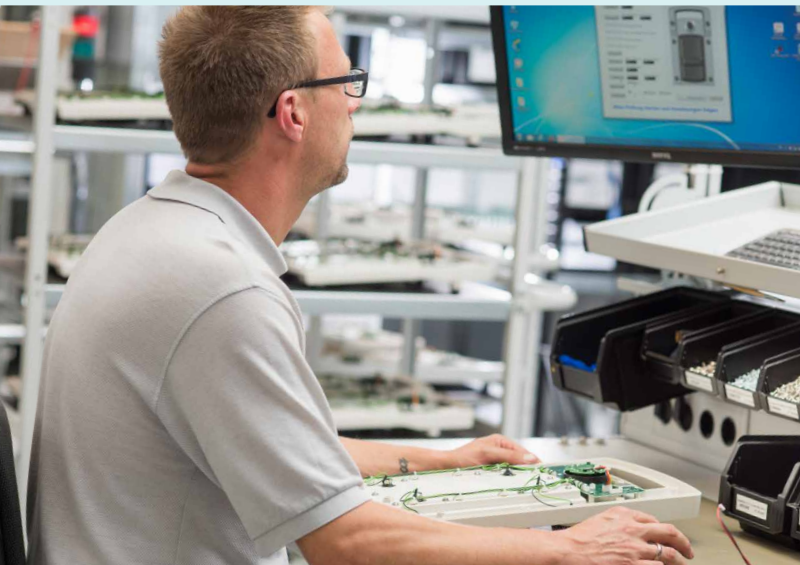

A specialist in a complex application field

In the OR, medical practices and rehabilitation clinics, the staff often literally have their hands full. For this reason, medical equipment is usually operated by foot control.

This complex field of human-machine interaction is the focus of steute business unit Meditec. Located in Löhne, we develop and produce top-quality user interfaces in close collaboration with our customers and always conforming to the official directives for medical devices. Our customers can choose between »Classic« controls from our standard range or »Custom« actuators developed according to customer requirements.

During the development of our controls, ergonomic comfort and intuitive operation are paramount: even complex procedures and extremely precise surgical tasks, such as tissue incision with an HF device or phacoemulsification of the retina, can be performed reliably and sensitively with our user interfaces. Equally important is the hygienic design of our controls. Both goals – ergonomic comfort and hygiene – benefit greatly from the remote control communication between the steute Meditec user interface and the medical device.

All our user interfaces comply with the relevant standards for medical devices as a matter of course. In addition to the IEC 60601 they fulfil all relevant medical laws and directives. During the approval process for a new medical device, steute Meditec supports its customers by providing comprehensive documentation (conforming to the relevant standards) of all tests and inspections performed on the user interface and its software (see pages 8-9).

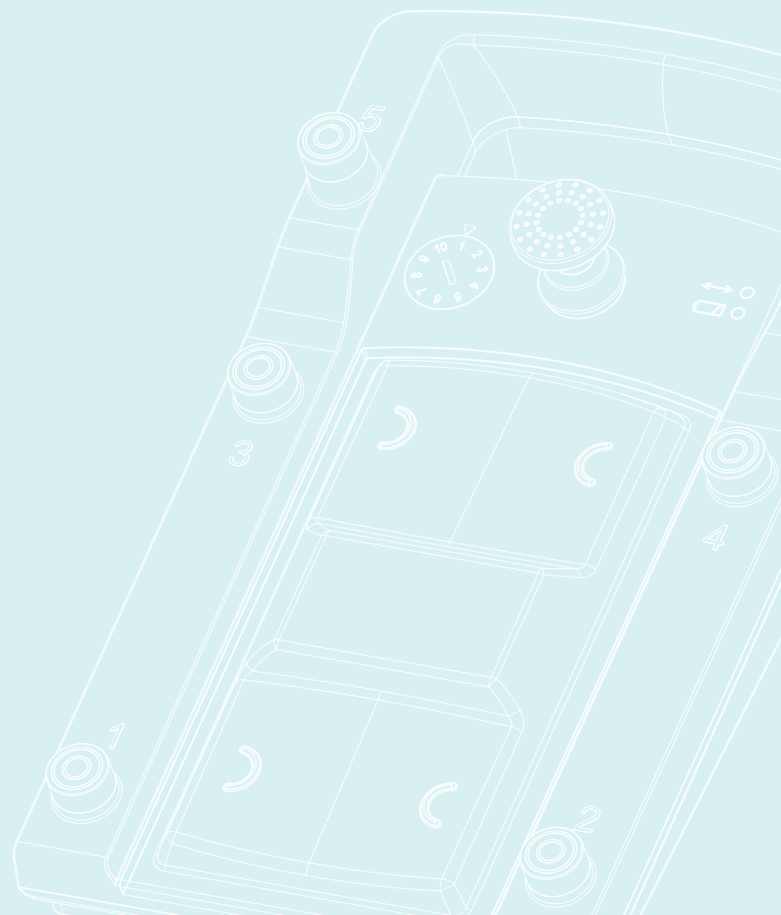

WIRELESS TECHNOLOGIES FOR MEDICAL EQUIPMENT – FROM 1998 UNTIL TODAY

1996 1997 1998



IT ALL STARTED WITH A CUSTOMER ENQUIRY

In 1981, steute began to develop and produce its first cabled foot controls for medical equipment. These foot controls and their successors were implemented by leading medical device manufacturers.

steute Meditec has been an independent business unit since 1997. One year later, in 1998, we received a customer enquiry from a manufacturer of dental cameras. The wish was for a wireless control unit, in order to achieve greater ergonomic comfort, and this was the start of steute wireless technology.

2001 2002 2003

2011 2012 2013



More than thirty years of skilled development

In 2000, steute Meditec developed its first wireless foot control to run on the 868 MHz frequency band. It was for a magnetic resonance imaging (MRI) device which would be used in a shielded MRI room, making this technology a reliable and unproblematic choice. Other medical applications, however, demanded a frequency band that was freely available for other environments all over the world.

That same year, a decision was made to implement the Bluetooth standard. By 2003, steute had developed its own wireless protocol suitable for medical devices. Today, steute controls using this technology can be found all over the world, with reliable signal transmission guaranteed by bidirectional communication and frequency hopping.

A wireless technology specifically for medical applications

Some extra development was still needed for the wireless systems, however, for example with regard to power consumption. This is why, in 2008, steute Meditec presented a new wireless technology developed from the outset specifically for medical applications, featuring very low power consumption, yet with reliable transmission and excellent coexistence.

This technology was developed further in 2017, resulting in the version which is currently available. This SW2.4LE-MED wireless technology from steute features maximum energy efficiency in conjunction with increased transmission performance (see pages 6/7). It is used in both the standard steute Meditec products and its customised controls.

Good reasons for using remote control in the OR and medical practices

Nearly all of the latest steute Meditec projects exploit the advantages of wireless technology – in areas such as ophthalmology, neurosurgery, surgical microscopes and imaging techniques like CT and MRI. Examination couches and dental chairs are also increasingly controlled without cables.

There are good reasons for this. Foot controls which are not connected by cable can be positioned more flexibly, facilitating more ergonomic operation of the medical device, and they are also more hygienic. The increased quality of a system incorporating a wireless user interface should not be underestimated. Remote control is a state-of-the-art technology which can help medical device manufacturers to set themselves apart from the competition.

Today: moving towards the interoperable OR

In collaboration with research institutes and manufacturers of medical devices, steute Meditec is currently working on research projects which also feature wireless communication. One goal here is the interoperable OR, in which several medical devices can be controlled using a single user interface.

2016 2017 2018

SW2.4LE-MED STATE-OF-THE-ART WIRELESS STANDARD FOR MEDICAL EQUIPMENT

The SW2.4LE-MED wireless technology in detail

SW2.4LE-MED	
Frequency	2,4 GHz ISM-Band
Frequency hopping	40 channels
Security	Retransmission, CRC24, 128-bit AES
Wake-up time	Typical 55 ms
Data transmission interval	20 ms
Transmission power	3-7 dBm
Power consumption	11 mA

6

Low energy – short connection times

One of the features of the new, third-generation SW2.4LE-MED wireless technology developed by steute is an extremely low energy consumption during active operation of just 11 mA. Thanks to a »sleep« mode, into which the wireless foot control falls when not used for a preconfigurable amount of time, the power consumption can be reduced to almost nothing. The shift back from the low-energy resting mode to the active mode is so fast that it goes unnoticed by the user: in practice the average wake-up time in real conditions is 50 to 60 milliseconds. The entire process chain takes place within this very short period: actuation of the foot control, »waking up« of the switch, transmission of the signal, arrival at the receiver unit, processing of the signal, and switching of the output signal.

Higher and more flexible transmission performance

While the power consumption of the wireless signal has been reduced, the transmission performance is actually higher than that of the previous wireless technology generation. In addition, transmission is now flexibly configurable, meaning that, for example, a user interface controlling an X-ray device can send signals to that device from a neighbouring control room. Clear assignation of foot control to corresponding receiver via the »pairing« procedure reliably prevents erroneous signalling and also facilitates interference-free operation of several wireless user interfaces inside one room or OR.

Powered by commercially available, not rechargeable batteries

The low energy consumption means that power can now be supplied by commercially available and no longer by rechargeable batteries. This means: both the effort of recharging and the charging device itself can be eliminated. With a conventional medical application profile, the batteries last for more than one and a half years, meaning that device manufacturers can replace them as part of their annual service. The battery status is displayed at all times.

International standards implemented

An extremely low residual error probability permits documentation of the transmission safety as below 1×10^{-9} 1/h. The wireless system hereby meets the requirements of SIL 3 (Safety Integrity Level to IEC 61508). A further advantage is its improved 128 bit-AES encryption, which also satisfies the security requirements of the FDA.



Power consumption in comparison

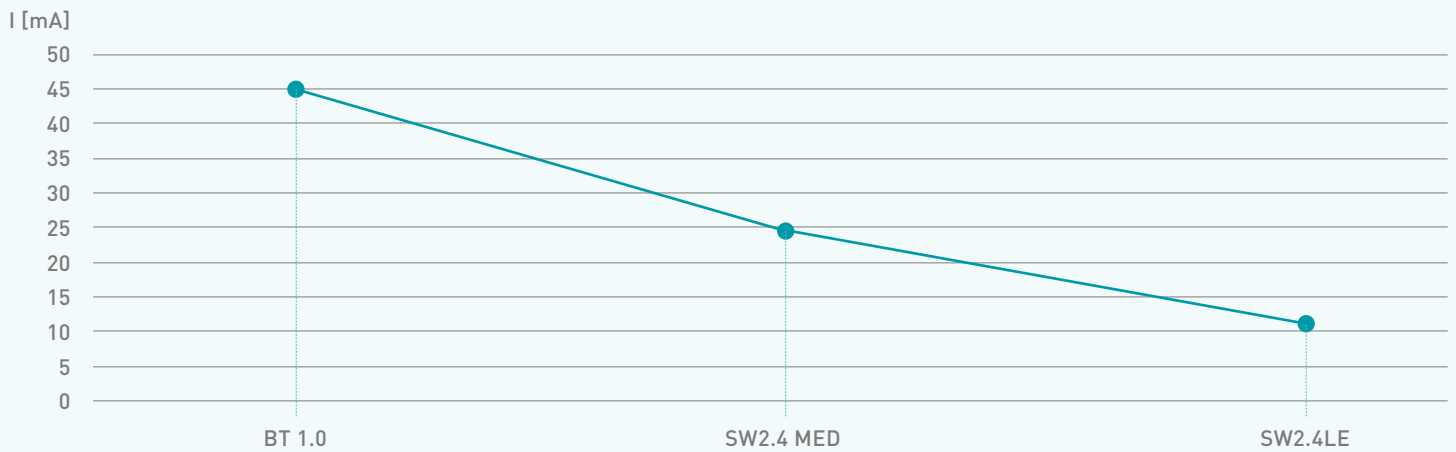

7

Battery Capacity

Power source	AA batteries	C batteries	Rechargeable battery
Capacity [mAh]	3000	8000	2500
Transmission time / day	1 h	1 h	1 h
Duration	230 days (replace batteries)	610 days (replace batteries)	190 days (recharge battery)

230 to 610 Days Duration



STANDARD COMPLIANT USE OF MODERN USER INTERFACES FOR MEDICAL DEVICES

Documentation requirements for radio systems in the OR

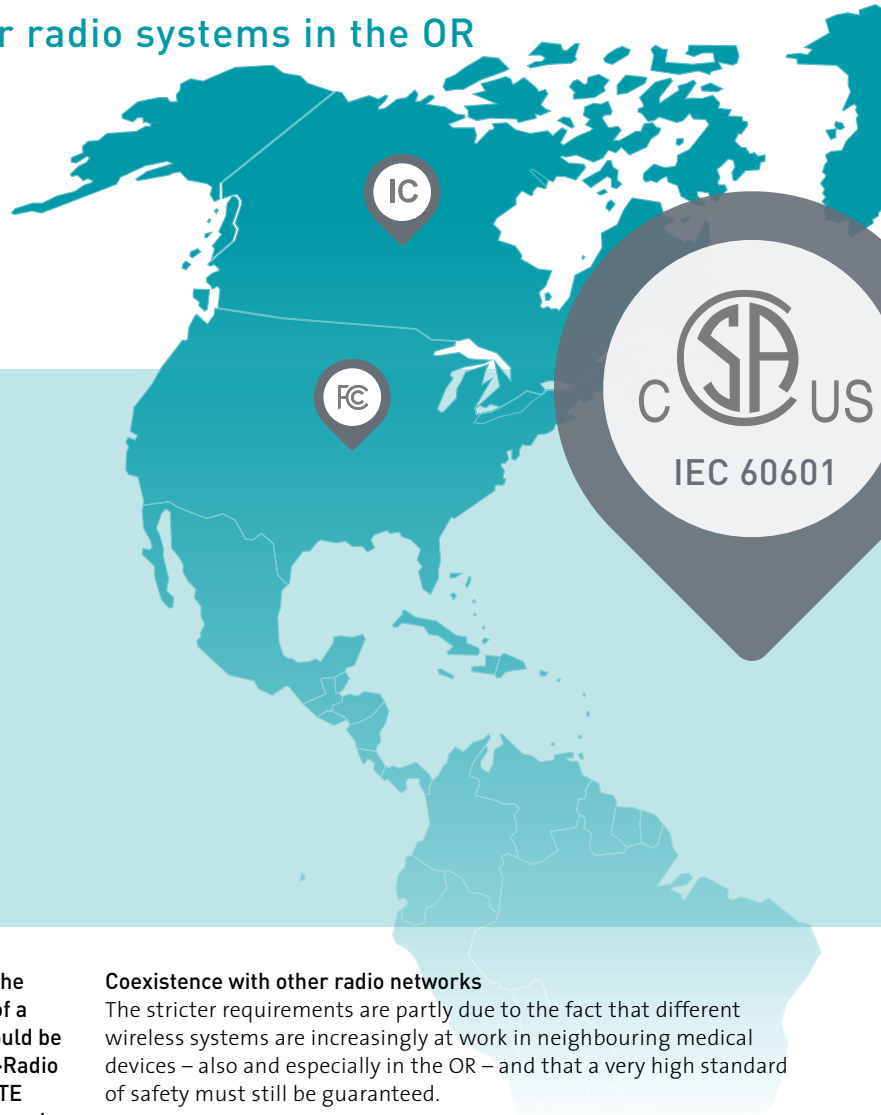

Full Modular Approval:

- USA: FCC
- Canada: IC
- Europe: RED Directive
- Japan: ARIB

Medical Certification IEC 60601-1 by CSA

8

New directives, standards and other requirements mean that the amount of documentation generated during the development of a medical device has increased considerably. Manufacturers should be aware that this is also true for wireless technologies. The EU »Radio Equipment Directive« (RED), which replaced the previous R&TTE directive has led, for example, to more compulsory inspections and more documentation. This is the case for the modified EMC directive for medical devices (IEC 60601-1-2:2016) as well which came into force in April 2017, and can also be the case for country-specific regulations regarding the use of radio equipment.

Coexistence with other radio networks

The stricter requirements are partly due to the fact that different wireless systems are increasingly at work in neighbouring medical devices – also and especially in the OR – and that a very high standard of safety must still be guaranteed.

Consequently, coexistence – potential mutual influencing of different radio systems – plays a major role in the various directives. For example, a coexistence inspection is mandatory for many radio networks and frequencies (Wi-Fi, Bluetooth, Zigbee, microwaves...). Conduction of these inspections must comply with the relevant standards (to IEEE/ ANSI C63.27), and the results must be correctly documented. The FDA also demands that medical device manufacturers produce evidence of coexistence for their wireless systems.

Approvals for all major markets

For our »Classic« range of user interfaces, presented in this brochure, the required evidence of conformity is easy for our customers to produce. These standard wireless controls have all been tested during their development in accordance with the relevant directives as a matter of course.

The wireless module we use is approved for major markets such as the USA (FCC), Canada (IC) and Japan (ARIB). The corresponding documentation for medical devices (including test reports) is supplied with our products, making it easy to integrate into the documentation of the finished medical device.



Inspection and documentation for customised controls

For our »Custom« range of user interfaces, the abovementioned inspections must be conducted and documented individually. The steute development team is experienced in this field and has set up a routine to provide our customers with as much assistance as possible regarding mandatory inspections and documentation.

The documentation always supplied with wireless controls from steute Meditec includes certificates of conformity with e.g. FCC (USA), IC (Canada), and MIC (Japan). The test results refer to the relevant directives (RED, EMC...) and the standards which are necessary to satisfy them, thus documenting that the wireless system complies with these directives.

»Simplification of Approval« for wireless controls

Ultimately it is the manufacturer, as the marketer of the finished medical device, who is responsible for producing this evidence. However, with the tests which steute has already conducted and the corresponding documentation including the test reports, the manufacturer only has to check the results of these tests to make sure that they are still appropriate once the user interface has been integrated within the overall system.

This procedure is known as »delta analysis« or »gap analysis«. It is far simpler to perform and thus faster and also cheaper. For wireless products which must comply with the relevant standards, the procedure is known as »Simplification of Approval« in the sense of the ETSI directive (ETSI EG 203 367).

»All inclusive«: certificate for global approval

After inspections and documented testing of its wireless (and customised) user interfaces, steute can optionally provide a »Certificate of Compliance«, issued following an independent inspection by the CSA. Moreover, steute can manage in the issuing of a »CB certificate« in line with the »CB scheme« familiar from electromedicine and accepted by international approval bodies.

Support with software inspections

Since individual software is created for our customised user interfaces, here too extensive inspection and documentation obligations apply. The various phases of the life cycle process to EN 62304 must be observed, and during the inspections all functions in the software specifications are checked. For this purpose, test specifications are drawn up prior to the creation of the software code, listing the target results. After programming, the target results are then compared with the actual results. The software can only be released when all inspections have been successfully completed. Here too, steute Meditec can assist customers by managing these inspections and thus contributing to shorter overall development times.

USER INTERFACES IN OUR »CLASSIC« RANGE



User interfaces in our standard product range

On the following pages we present the user interfaces from our »Classic« range. They can be used universally for all types of medical equipment and can be adapted to a specific device or situation with a variety of options. Our current focus is a new standard range of battery-powered wireless foot controls with one to four pedals.

These foot controls work with SW2.4LE-MED, the latest steute wireless technology generation (see page 5). Power is supplied by commercially available alkaline batteries (AA or C) and no longer by lithium-ion rechargeable batteries. The level of safety achieved by our wireless technology is high, at SIL 3 to IEC 61508, likewise the risk management of the software (EN 62304), categorised as safety class C.

As well as optimising the power supply and achieving an even higher level of transmission reliability and an even longer lifespan, the steute designers have attached great importance to ergonomic design, i.e. to non-tiring and intuitive operation of our foot controls. Above the pedals there are optional push buttons which can also be actuated by foot. A carrying bar makes it easier to position the foot control, while wireless signal transmission gives users additional freedom of movement without the restriction of a cable (which can also be unhygienic).

Specialists for specific medical fields

In addition to our new standard wireless foot controls, the steute Meditec range of user interfaces also contains »specialists« which have been developed for specific medical fields and tasks – for example surgical microscopes, eye surgery and laser applications (from page 16). Another product focus is wireless hand controls (page 22).

A further option: tailor-made solutions

The engineers at steute Meditec have realised many tailor-made solutions in collaboration with manufacturers of medical devices, developed specifically with a concrete application or individual requirement profile in mind.

Areas using such solutions to date range from dental equipment to laser-based surgery to ophthalmology to imaging techniques (CT, MRI, X-ray).

For more detailed information about tailor-made solutions and user interfaces, please talk to our steute Meditec experts directly.

ONE-PEDAL FOOT CONTROLS

The one-pedal foot controls from our GP111 series are often used to operate speed-controlled drives and instruments – for example dental applications in implantology, and neurosurgery. Important from the user's point of view is the high degree of ergonomic comfort, facilitating intuitive operation and sensitive speed regulation.



MKF SW2.4LE-MED GP111



Features / options

- Impact-resistant thermoplastic housing, ideal for steute wireless integration
- Wireless signal transmission via steute wireless low energy
- Power supply via 3 commercially available batteries (AA)
- Battery compartment can be opened by hand
- Protection class IP X8 (IEC 60529)
- Collapsible handle
- Additional push buttons
- LEDs
- Different RAL colours

Please note:

Fig. shows optional accessories

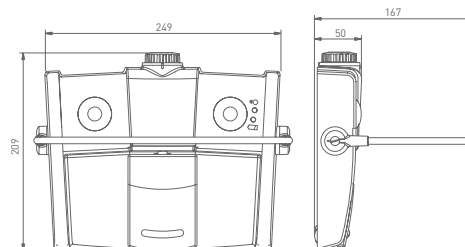
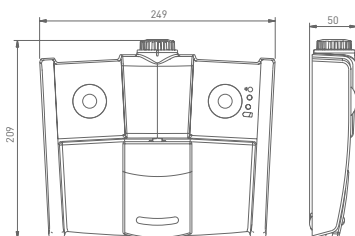

TWO-PEDAL FOOT CONTROLS

The two-pedal wireless foot controls from steute Meditec are true »universalists«, suitable for a wide range of applications. These user interfaces can be adapted to suit the wishes of the customer – for example with additional push buttons or a collapsible handle. The switch can send both analogue and digital signals. Frequent areas of use are mobile X-ray machines and electrosurgery.



MKF 2 SW2.4LE-MED GP211



Features / options

- Impact-resistant thermoplastic housing, ideal for steute wireless integration
- Wireless signal transmission via steute wireless low energy
- Power supply via 3 commercially available batteries (C)
- Battery compartment can be opened by hand
- Protection class IP X8 (IEC 60529)
- Collapsible handle
- Additional push buttons
- LEDs
- Different RAL colours

Please note:

Fig. shows optional accessories

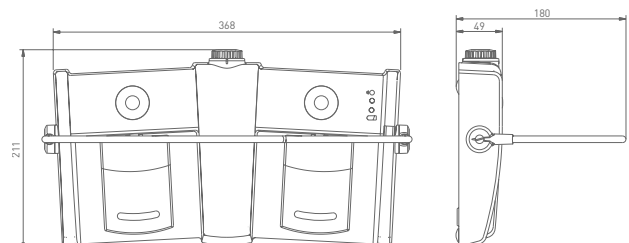
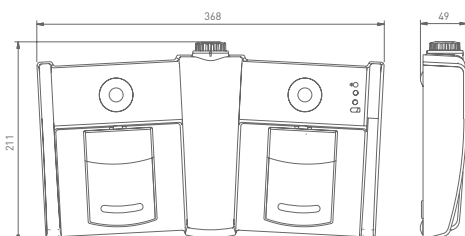

THREE-PEDAL FOOT CONTROLS

The GP311 combines three foot controls and optional extra elements in a single unit. The functions of the different elements can be configured individually to suit requirements. Like the one and two-pedal wireless user interfaces, the three-pedal variants are produced and supplied in accordance with the customer's wishes regarding not only the number of elements, but also the appearance (colour, label) – for example to manufacturers of imaging devices.



MKF 3 SW2.4LE-MED GP311



Features / options

- Impact-resistant thermoplastic housing, ideal for sterile wireless integration
- Wireless signal transmission via steute wireless low energy
- Power supply via 3 commercially available batteries (AA)
- Battery compartment can be opened by hand
- Protection class IP X8 (IEC 60529)
- Collapsible handle
- Additional push buttons
- LEDs
- Different RAL colours

Please note:

Fig. shows optional accessories

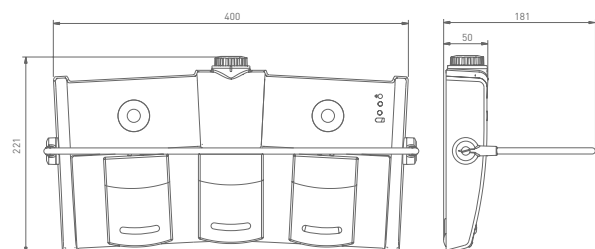
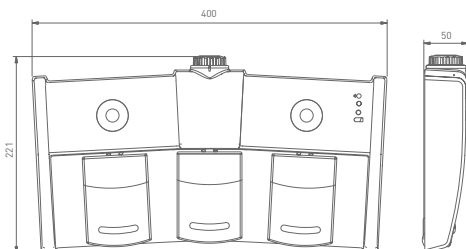

FOUR-PEDAL FOOT CONTROLS

When user interfaces have four pedals and maybe also additional push buttons, intuitive actuation is vital. Typical applications include mammography and the adjustment of operating tables.



MKF 4 SW2.4LE-MED GP411



Features / options

- Impact-resistant thermoplastic housing, ideal for sterile wireless integration
- Wireless signal transmission via sterile wireless low energy
- Power supply via 3 commercially available batteries (AA)
- Battery compartment can be opened by hand
- Protection class IP X8 (IEC 60529)
- Collapsible handle
- Additional push buttons
- LEDs
- Different RAL colours

Please note:

Fig. shows optional accessories

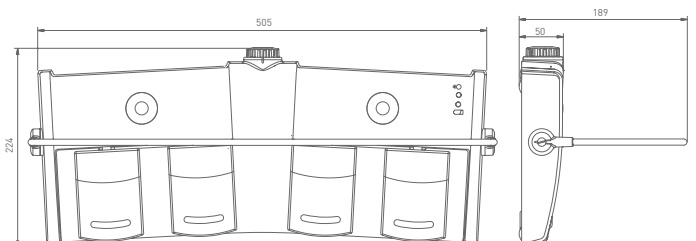
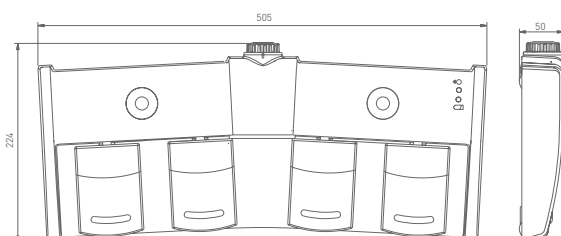
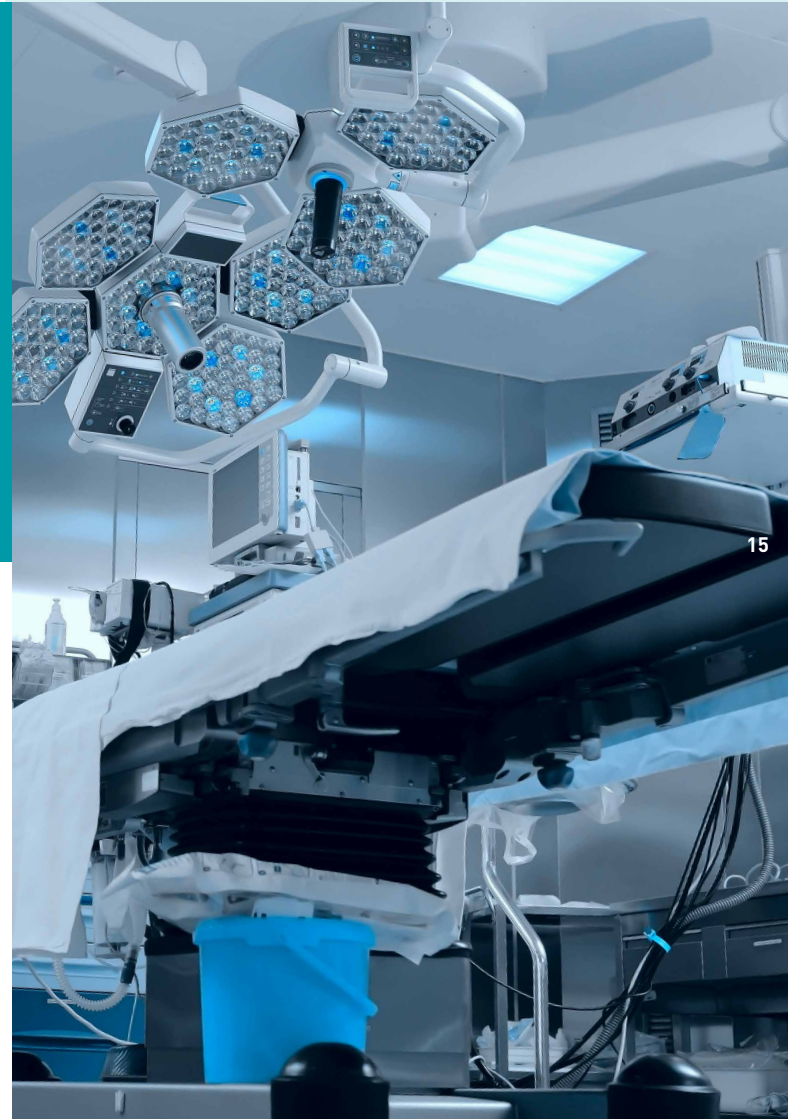

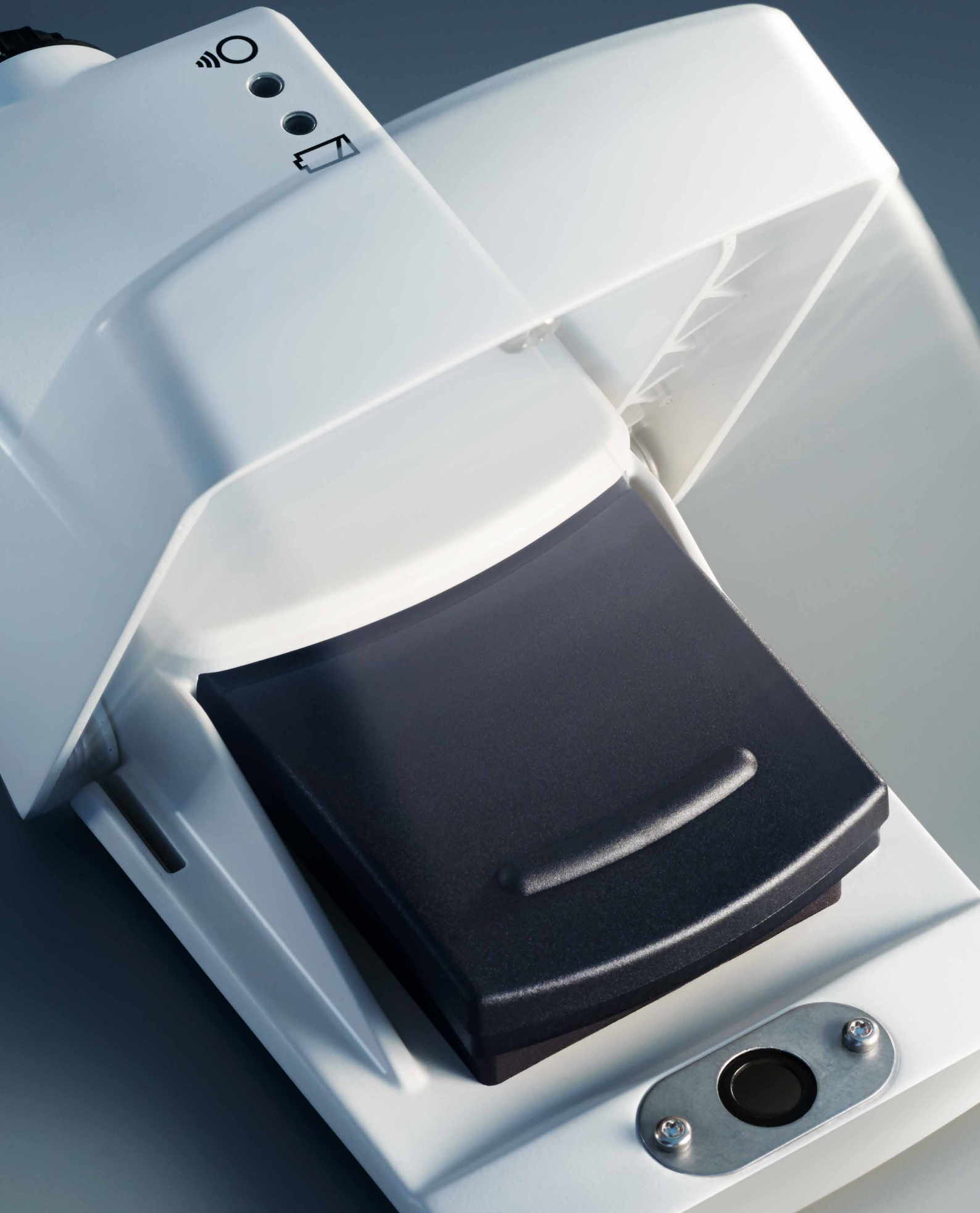

FOOT CONTROL WITH FOLDING PROTECTIVE COVER

steute Meditec has developed a wireless foot control with a folding protective cover especially for laser technology. This user interface also works with the latest SW2.4LE-MED low-energy wireless technology and can thus be powered via commercially available instead of rechargeable batteries. The protective cover prevents unintended actuation of the pedal, as required by the standards for user interfaces controlling surgical and cosmetic laser devices. Of course, these foot controls can also be used in other applications where unintended actuation must be avoided.



MKF SW2.4LE-MED SK13



Features / options

- Impact-resistant thermoplastic housing, ideal for steute wireless integration
- Developed especially for surgical or cosmetic laser devices to IEC 60601-2-22 standards
- Lockable protective cover prevents unintended actuation
- Wireless signal transmission via steute wireless low energy
- Power supply via 3 commercially available batteries (AA)
- Battery compartment can be opened by hand
- Protection class IP X8 (IEC 60529)
- LEDs
- Different RAL colours

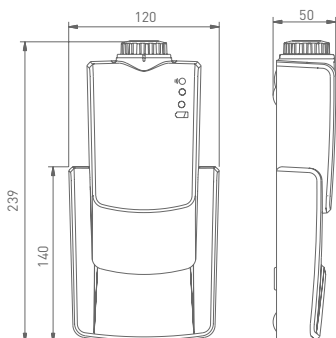
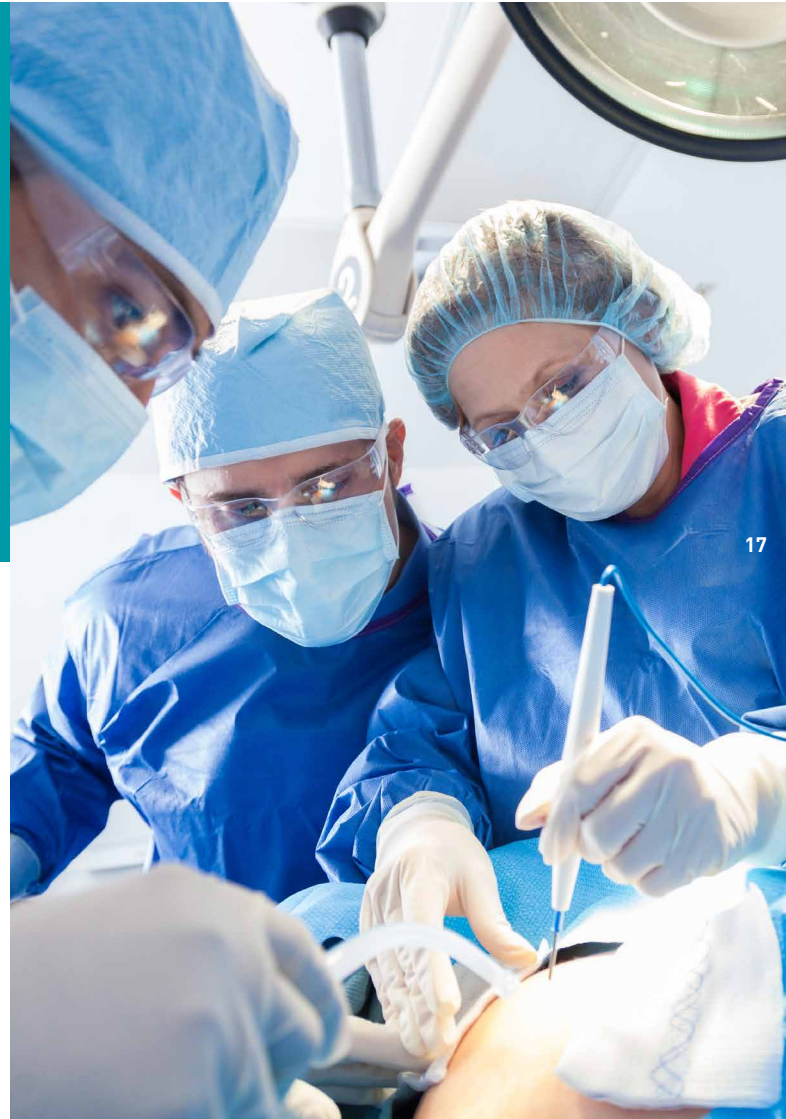

TWO-PEDAL FOOT CONTROLS

A true success story in our range of wireless foot controls is the two-pedal MKF 2-MED GP212. Our business unit steute Meditec has been producing this series for several years already, the latest generation with the universal RF SW2.4LE MED technology. This series is built according to wishes of the customer. Options include the integration of additional push buttons and/or a handle for easy positioning. The switch can transmit both analogue and digital signals. Application examples include HF surgery, X-ray and neurosurgery.



MKF 2 SW2.4LE-MED GP212



Features / options

- Impact-resistant thermoplastic housing, ideal for steute wireless integration
- Wireless signal transmission via steute wireless low energy
- Power supply via rechargeable Li-Ion battery
- Socket for recharging battery
- Protection class IP X8 (IEC 60529)
- Handle for easy positioning
- Additional push buttons
- LEDs
- Different RAL colours

Please note:

Fig. shows optional accessories

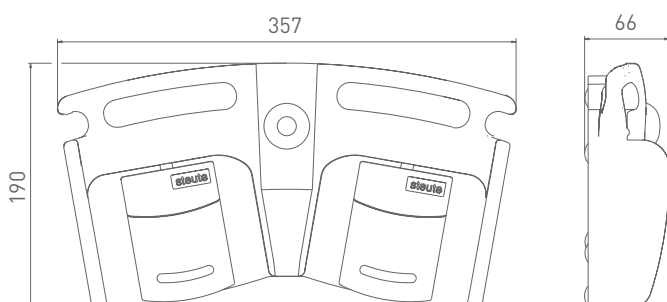

THREE-PEDAL FOOT CONTROLS

The MKF 3-MED GP34 combines three foot controls and optional extra elements in a single unit. The functions of the different elements can be configured individually to suit requirements. They are produced and supplied in accordance with the customer's wishes regarding not only the number of elements, but also the appearance (colour, label).



MKF 3 SW2.4LE-MED GP34



Features / options

- Aluminium alloy housing
- Wireless signal transmission via steute wireless low energy
- Power supply via rechargeable Li-Ion battery
- Socket for recharging battery
- Protection class IP X8 (IEC 60529)
- Handle for easy positioning
- Additional push buttons
- LEDs
- Different RAL colours

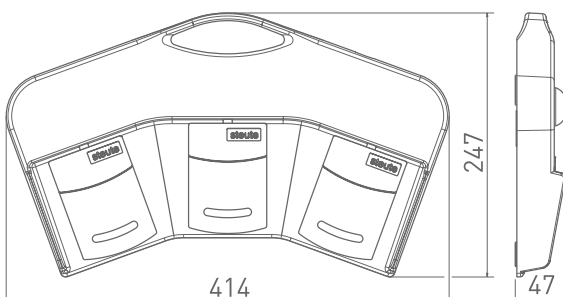
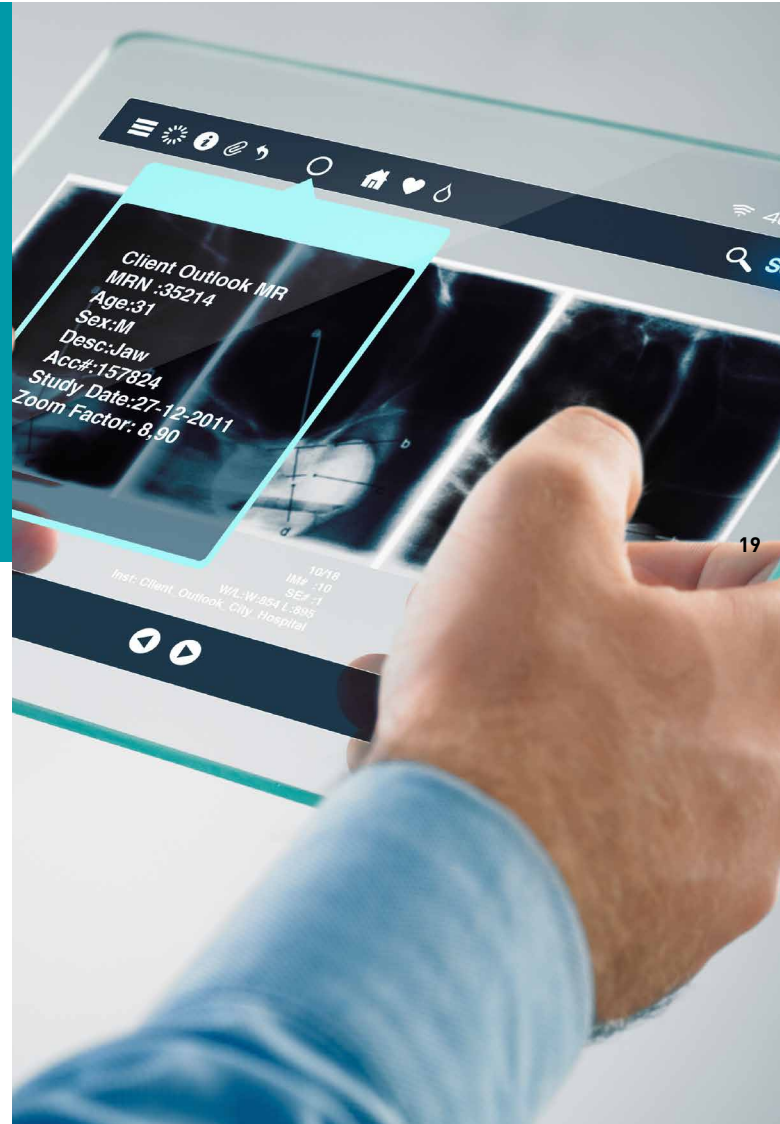

SURGICAL MICROSCOPE FOOT CONTROL

Focus, zoom, brightness, shot...: these are just some of the many functions which a foot control for a surgical microscope must perform. If it is a wireless control, surgeons benefit from extra flexibility. The actuator elements are arranged for maximum ergonomic comfort and include a joystick, 6 additional push buttons and two rocker switches.

MFS MICROSCOPE SW2.4LE-MED



Features / options

- Impact-resistant thermoplastic housing, ideal for sterile wireless integration
- Wireless signal transmission via sterile wireless low energy
- Power supply via 3 commercially available batteries (C)
- Battery compartment can be opened by hand
- Protection class IP X8 (IEC 60529)
- Zoom and focus function with middle foot rest
- Joystick for positioning of microscope
- 6 additional push buttons with programmable functions
- Easy to clean
- LEDs
- Different RAL colours

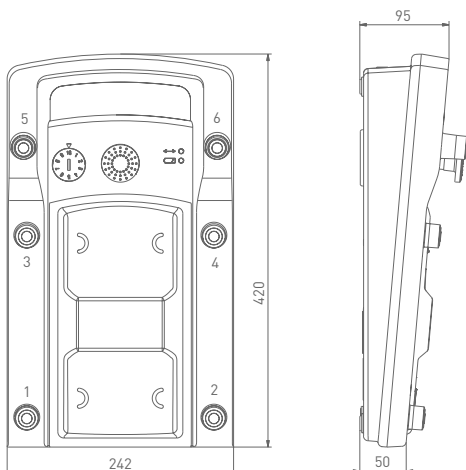

OPHTHALMOLOGY FOOT CONTROL

This foot control was developed especially for phacoemulsification, a common procedure in ophthalmology. The foot of the surgeon rests on a central pedal with a dual-linear function (pitch and yaw). The pedal travel can be individually adjusted, as can the force necessary for actuation. Optional, programmable pressure points give the surgeon feedback regarding the position of the pedal. Four additional elements, which as »rockers« can be fitted with up to 8 different switching functions, can be actuated with the toes or heel. In addition, the controls can be fitted with different functions for different operational modes.

MFS PHACO SW2.4LE-MED

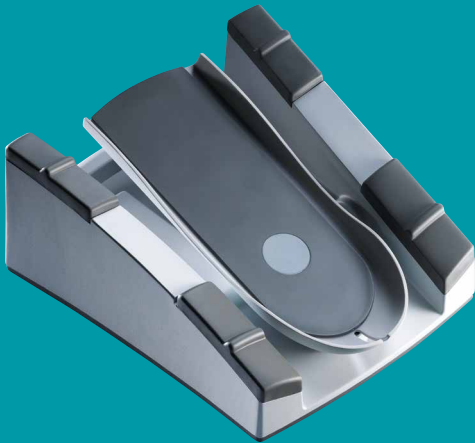

Features / options

- Impact-resistant thermoplastic housing, ideal for sterile wireless integration
- Wireless signal transmission via steute wireless low energy
- Power supply via rechargeable Li-Ion battery
- Socket for recharging battery
- Protection class IP X8 (IEC 60529)
- Vertical and horizontal pedal with proportional output signal
- Programmable braking points for tactile feedback
- Intuitive operation with maximum precision
- Easy to clean
- LEDs
- Different RAL colours

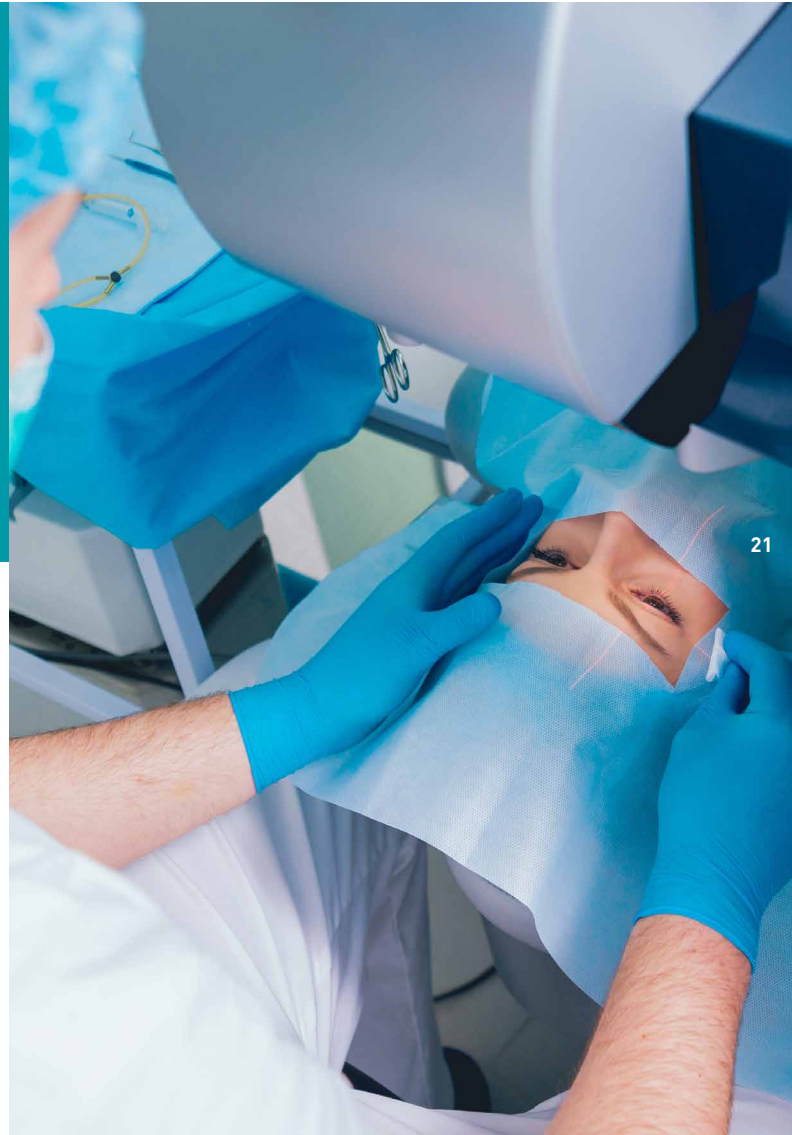
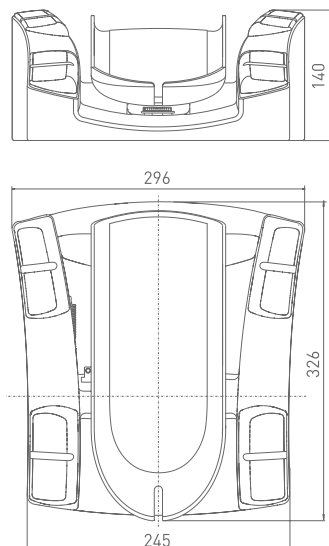

WIRELESS HAND CONTROL FOR MEDICAL EQUIPMENT

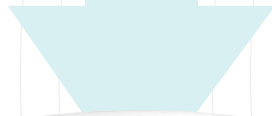

22



The SW2.4LE-MED wireless technology also has advantages when used with hand controls for the OR or medical practices. This is why steute has additionally developed a hand remote control. The FFB-MED has seven digital functions which can be individually configured as required, depending on the medical device. Two-stage redundant membrane buttons are optionally available, enabling this control to be used in situations requiring very high safety levels.

The hand control is comfortable to hold, while its membrane keypad make it easy to clean and put it in a high protection class (IP 65). The membrane keypad can be adapted to suit the wishes of the customer.

The low-energy wireless signal means that lightweight alkaline batteries can be used, further increasing ease of use. The special wireless technology with its short transmission times makes the FFB-MED suitable for many different applications throughout the medical field.

WIRELESS HAND CONTROL FFB-MED

FFB SW2.4LE-MED



23

Features / options

- Impact-resistant thermoplastic housing, ideal for steute wireless integration
- Wireless signal transmission via steute wireless low energy
- Power supply via 3 commercially available batteries (AA)
- Membrane keypad with different functions
- Ergonomic design
- Easy to clean
- LEDs
- Different RAL colours

Please note:

Fig. shows optional accessories

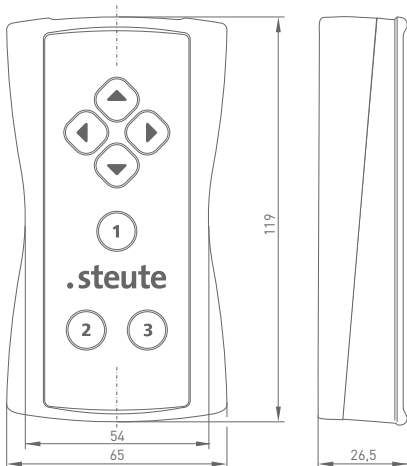



steute develops and manufactures safe switchgear for demanding and critical applications. Besides a comprehensive standard range of products for »Wireless, Automation, Extreme and Meditec« applications, we also and increasingly develop customised switchgear for extreme conditions in all four business fields. Some examples: emergency pullwire switches for the mining industry, position switches for industrial automation and control panels for laser surgery. Our head office is in Löhne, Westphalia, Germany; worldwide sales are conducted through steute's subsidiaries and trading partners.

For further information or individual service, please contact us. Detailed information can also be found at: www.steute.com

steute Technologies GmbH & Co. KG
Brückenstraße 91
32584 Löhne, Germany
Phone + 49 (0) 57 31 7 45-0
Fax + 49 (0) 57 31 7 45-200
meditec@steute.com
www.steute-meditec.com

